

**MANUAL – SERVICE + INSTALLATION**

---

# **BACnet Flow Controller for Fan Filter Units**

## BFC Series

**v500 – Issue Date: 06/29/2022**

© 2022 Price Industries Limited. All rights reserved.

**PRICE**<sup>®</sup>

# BACNET FLOW CONTROLLER

## TABLE OF CONTENTS

### Product Overview

General Information .....	1
---------------------------	---

### Installation & Mounting Instructions

Typical Wiring .....	2
----------------------	---

Input/Output Description .....	2
--------------------------------	---

### Display Navigation

Initial Startup .....	3
-----------------------	---

Main Menu .....	4
-----------------	---

Service Menu .....	5
--------------------	---

Service Menu – Fan.....	6
-------------------------	---

Service Menu – Filter .....	7
-----------------------------	---

Service Menu – I/O.....	8
-------------------------	---

Service Menu – BACnet .....	9
-----------------------------	---

Service Menu – Diagnostics .....	9
----------------------------------	---

### Filter Calibration

Filter Calibration using BFC Interface .....	10
--	----

Filter Calibration over BACnet.....	11
-------------------------------------	----

### Networking & Setup

BACnet Wiring .....	12
---------------------	----

Termination .....	12
-------------------	----

Electrical Noise.....	12
-----------------------	----

Network Wire Specifications.....	13
----------------------------------	----

BACnet Service Menu .....	14
---------------------------	----

BACnet Networking and Setup .....	15
-----------------------------------	----

Setting the Device Instance (Coupled MAC and DI) .....	16
--	----

Setting the Device Instance (De-coupled MAC and DI) .....	17
---	----

Network Layout.....	18
---------------------	----

Package/Component Identification.....	20
---------------------------------------	----

Location .....	21
----------------	----

Mounting.....	22
---------------	----

BAS Input Signal .....	23
------------------------	----

Analog RPM Feedback.....	24
--------------------------	----

Wiring and Cables.....	25
------------------------	----

### Maintenance

Troubleshooting.....	26
----------------------	----

Specifications.....	27
---------------------	----

BACnet points list for BFC firmware v3.1.0.....	28
---	----

# BACNET FLOW CONTROLLER

## PRODUCT OVERVIEW

### General Information

The BACnet Flow Controller (BFC) is a DDC fan controller designed specifically for controlling flow through Fan Filter Units (FFU) with EC motor technology. The BFC controls an EC motor through a local setpoint which is adjustable using a push button interface on the BFC, by an analog BAS input voltage, or over BACnet.

In addition to fan control, the BFC can monitor filter pressure drop, filter loading, signal for filter changes, monitor the motor and filter lifetime in hours, as well as report airflow and air temperature over the filter. This information can be viewed from the LCD screen on the front of the BFC controller, or over BACnet on a building management system.

**NOTE:** This manual only covers the BFC controller. For troubleshooting an ECM motor, please visit <http://www.priceindustries.com> and download the ECM Motor Troubleshooting Manual.

### FRONT OF BFC CONTROLLER ▼



- 1 Service Port RJ12 Jack
- 2 BACnet Connection RJ45 Jacks
- 3 Up and Down arrow buttons for navigation
- 4 Menu button for info menu and entering Service menus

### BACK OF BFC CONTROLLER ▼

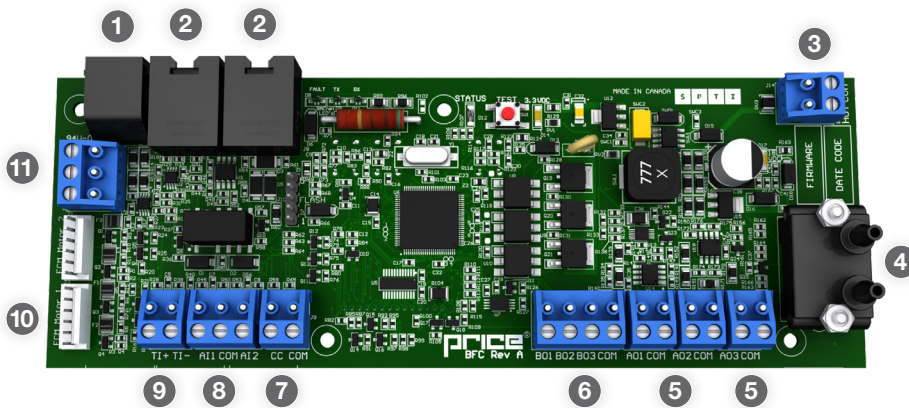

- 1 Service Port RJ12 Jack
- 2 BACnet Connection RJ45 Jacks
- 3 24 VAC Power Connection
- 4 Pressure Transducer
- 5 0-10 VDC Analog Outputs
- 6 24 VAC Binary Outputs
- 7 Contact Closure
- 8 Analog Inputs
- 9 Thermistor Input
- 10 Motor #1 Jack
- 11 BACnet MS/TP Terminals

# BACNET FLOW CONTROLLER

## INSTALLATION & MOUNTING INSTRUCTIONS

### Typical Wiring

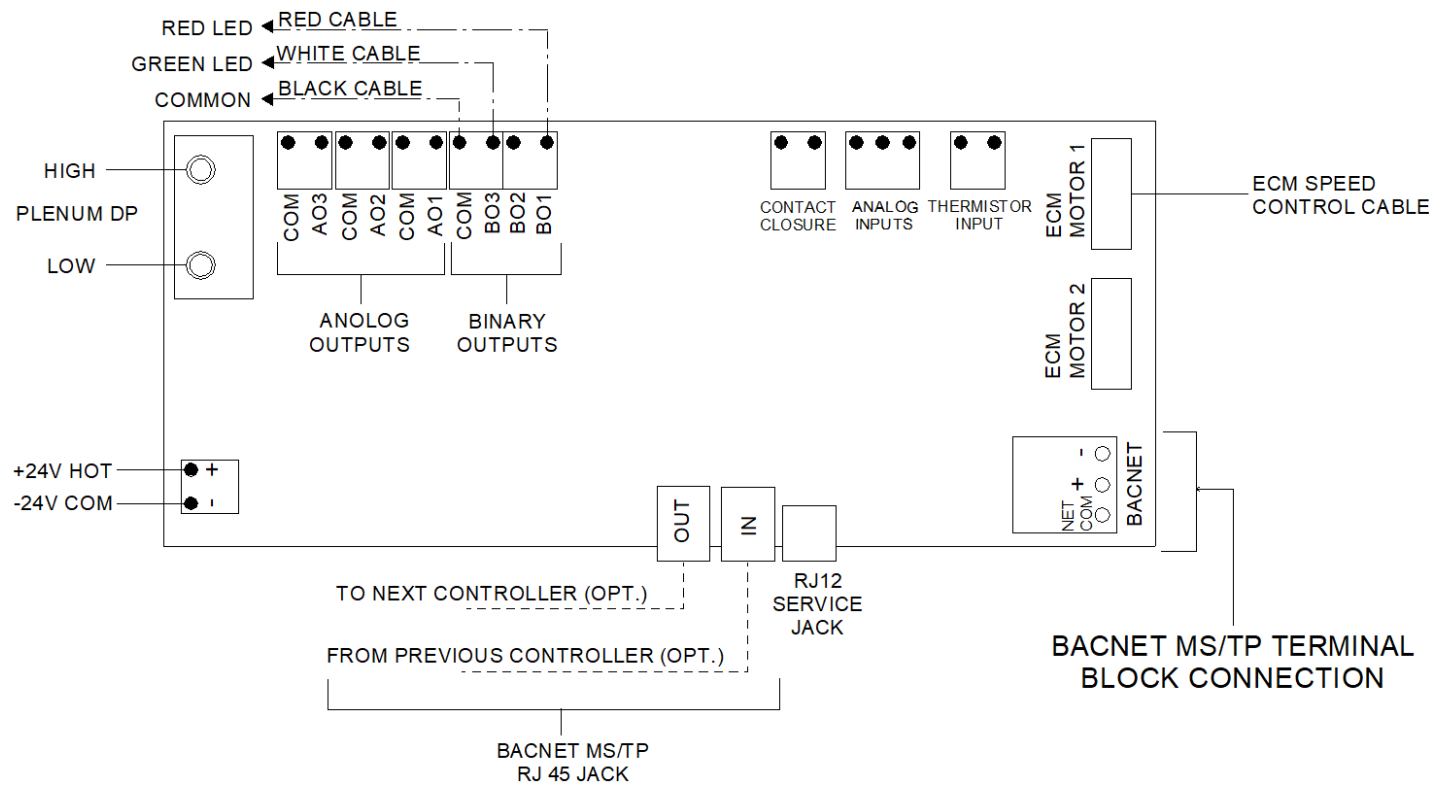

### Input/Output Description

Analog Outputs	
AO1	Configurable for Unit Pressure, CFM (Air Flow), RPM (Motor Speed), Filter Load , BAS, *LED Dimming, *LED On/Off (*for UFFU w/ BACnet Dimming Control)
AO2	Configurable for Unit Pressure, CFM (Air Flow), RPM (Motor Speed), Filter Load , BAS, *LED Dimming, *LED On/Off (*for UFFU w/ BACnet Dimming Control)
AO3	Configurable for Unit Pressure, CFM (Air Flow), RPM (Motor Speed), Filter Load , BAS, *LED Dimming, *LED On/Off (*for UFFU w/ BACnet Dimming Control)
24 VAC Binary Outputs	
BO1	Red LED out
BO3	Green LED out
COM	COMMON
Analog Inputs	
AI1	Input voltage for remote fan speed control
AI2	Input voltage for LED control (*for UFFU w/ BACnet Dimming Control)
Inputs	
Thermistor Input	Analog input for monitoring air over filter temperature, 10k type J thermistor
Contact Closure	Binary input to activate secondary ECM setpoint.

# BACNET FLOW CONTROLLER

## DISPLAY NAVIGATION

### Initial Startup

When the BFC controller is powered up with 24VAC it will display the following information.

<b>PRICE ELECTRONICS</b>	Start-up screen
<b>BFC VERSION</b>	Displays firmware version
<b>CURR PRESSURE</b>	Displays the current static pressure in in. w.g.
<b>ECM SETPOINT</b>	Displays ECM setpoint in % motor speed
<b>UNIT STATUS</b>	Displays current unit status (Off, Low Pressure, Normal, Filter Loaded)
<b>CONTROL MODE</b>	Displays the current control mode (BACnet, BAS, Local Control)
<b>CURRENT CFM</b>	Displays the current airflow (only visible with the Constant Flow motor program)

\*LCD display will cycle between Curr Pressure, ECM Setpoint, Unit Status, Control Mode, and Current CFM during normal operation.

### Change ECM motor setpoint using ▲ and ▼ arrow keys

<b>LOCAL ECM 58%</b>	Setpoint will save after being adjusted with arrow keys
--------------------------	---

**NOTE:** Local setpoints are stored to EEPROM and will remain set after power failures.



# BACNET FLOW CONTROLLER

## DISPLAY NAVIGATION

### Main Menu

From the Home Screen press the Menu button to enter this menu. Use Up and Down arrow buttons to navigate through.

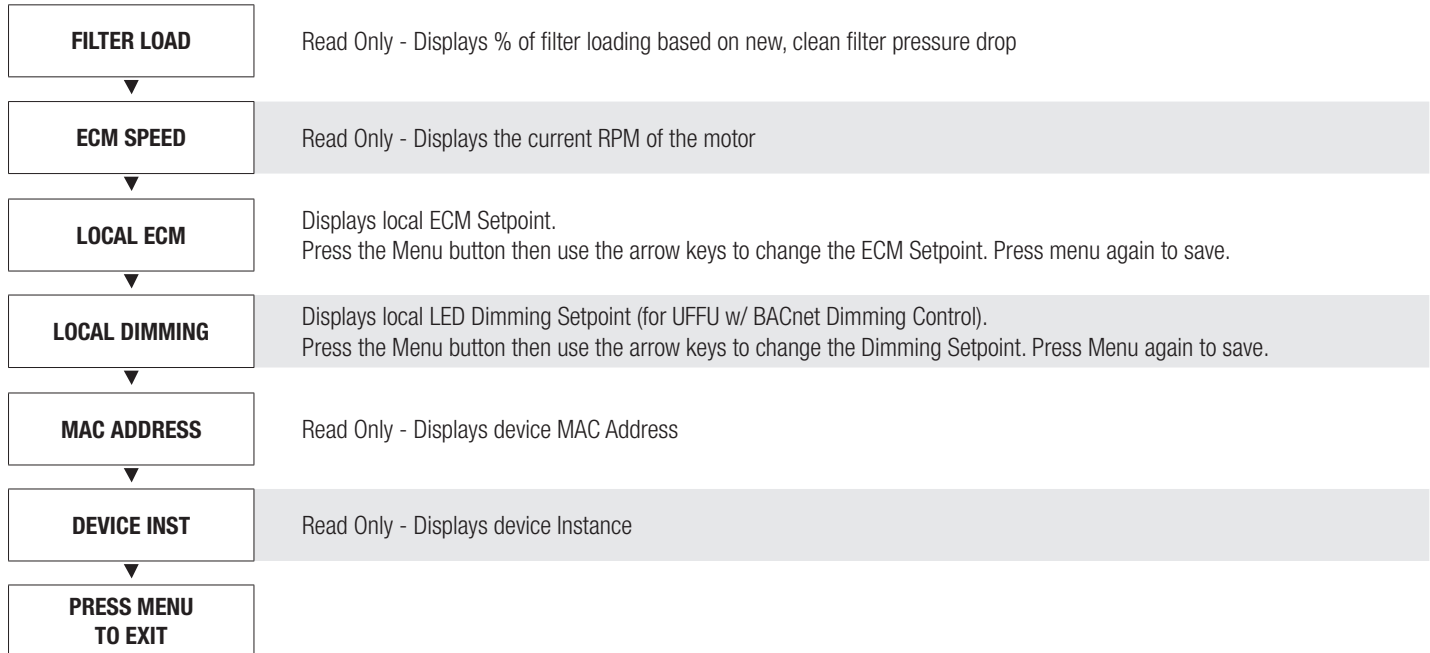

**NOTE:** Local setpoints are stored to EEPROM and will remain set after power failures.

# BACNET FLOW CONTROLLER

## DISPLAY NAVIGATION

### Service Menu

Hold down Menu button for 5 seconds, display will show 'Passcode'. Use Up and Down arrow buttons to enter this sequence: **Down, Up, Up, Down.**

<b>SERVICE MENU FAN</b>	Allows you to see or adjust: Current CFM CFM Offset CFM Tweak ECM Setback Fan Type Unit Size ie. 2X2 Wheel Type Voltage Type Motor Runtime (in hours) Reset Motor Runtime
<b>SERVICE MENU FILTER</b>	Filter Load Load Trip Current Pressure Filter Type Filter Runtime (in hours) Reset Filter
<b>SERVICE MENU I/O</b>	Analog In 1 (BAS ECM SP) Analog In 2 (BAS LED SP) Analog Out 1 (Present Value) Analog Out 1 (A01 Usage) Analog Out 2 (Present Value) Analog Out 2 (A02 Usage) Analog Out 3 (Present Value) Analog Out 3 (A03 Usage)
<b>SERVICE MENU BACNET</b>	MAC Address Device Instance Baud Rate RS-485 Termination BACnet Reset
<b>SERVICE MENU DIAGNOSTICS</b>	Restore Defaults Total Device Reset Factory Configuration Reset

# BACNET FLOW CONTROLLER

## DISPLAY NAVIGATION

### Service Menu – Fan

Press Menu button to enter this menu. Use Up and Down arrow buttons to navigate through.

<b>CURRENT CFM</b> <b>XXXX CFM</b>	Read Only
<b>UNIT STYLE</b>	Supply, Exhaust, CARES <b>NOTE:</b> Must match actual configuration of FFU
<b>UNIT SIZE</b> <b>2X2</b>	Displays the ECM motor calibration for FFU nominal size (2x2) Selectable sizes are: 2' x 2', 2' x 3', 2' x 4' <b>NOTE:</b> Must match actual configuration of FFU.
<b>WHEEL TYPE</b> <b>XXX</b>	Adjust unit wheel type from FC to BC. Read only varying on fan type and unit size The wheel type is factory set, but it can be adjusted only under the Constant Torque setting. From there, you can set the wheel type to BC on 2' x 3' and 2' x 4' units only. <b>NOTE:</b> BC wheel type is for Constant Torque only.
<b>VOLTAGE TYPE</b> <b>XXX</b>	Adjust unit voltage type from 115/240/277.
<b>MOTOR PROGRAM</b> <b>XXX</b>	Adjust fan type from Constant Volume to Constant Torque. Airflow (CFM) will be hidden if fan type is constant torque
<b>MOTOR RUNTIME</b> <b>0 HRS</b>	Read Only – Displays number of hours on motor since last reset
<b>RESET MOTOR RUNTIME</b>	Resets Motor Runtime
<b>CFM OFFSET</b> <b>0 CFM</b>	Adjust airflow reading +/- up to 500 CFM to coincide with balancer measured airflow Example: flow hood reads 550 CFM Airflow reading on BFC is 500 cfm Adjust CFM offset to +50 CFM
<b>CFM TWEAK</b> <b>100 %</b>	Adjust airflow reading between 50 to 200% Example: flow hood reads 550 CFM Airflow reading on BFC is 500 cfm Adjust CFM tweak to +110%
<b>ECM SETBACK</b>	Secondary setpoint for use in turndown or night setback applications. This is activated upon contact closure.
<b>PRESS MENU TO EXIT</b>	



# BACNET FLOW CONTROLLER

## DISPLAY NAVIGATION

### Service Menu – Filter

Press Menu button to enter this menu. Use Up and Down arrow buttons to navigate through.

<b>FILTER TYPE</b> <b>XXX</b>	Adjust filter type, BTR, RSR. BTR = Bench Top Removable RSR = Room Side Removable
<b>FILTER LOAD</b> <b>XX %</b>	Read Only - Displays % of filter loading based on new, clean filter pressure drop
<b>LOAD TRIP</b> <b>1.50</b>	This read only value represents the ratio between clean and loaded filter pressure. It is factory set for 1.5 times the clean filter pressure and is not field adjustable. Example: If the filter calibrated pressure is 0.16 in. w.g., the loaded filter pressure will be 0.24 in. w.g.
<b>FILTER RUNTIME</b> <b>0 HRS</b>	Read Only – Displays number of hours on filter since last reset
<b>RESET</b> <b>FILTER</b>	Resets Filter Runtime. Activate this to calibrate filter pressure during initial setup or filter replacement.
<b>PRESS MENU</b> <b>TO EXIT</b>	

# BACNET FLOW CONTROLLER

## DISPLAY NAVIGATION

### Service Menu – I/O

Press Menu button to enter this menu. Use Up and Down arrow buttons to navigate through.

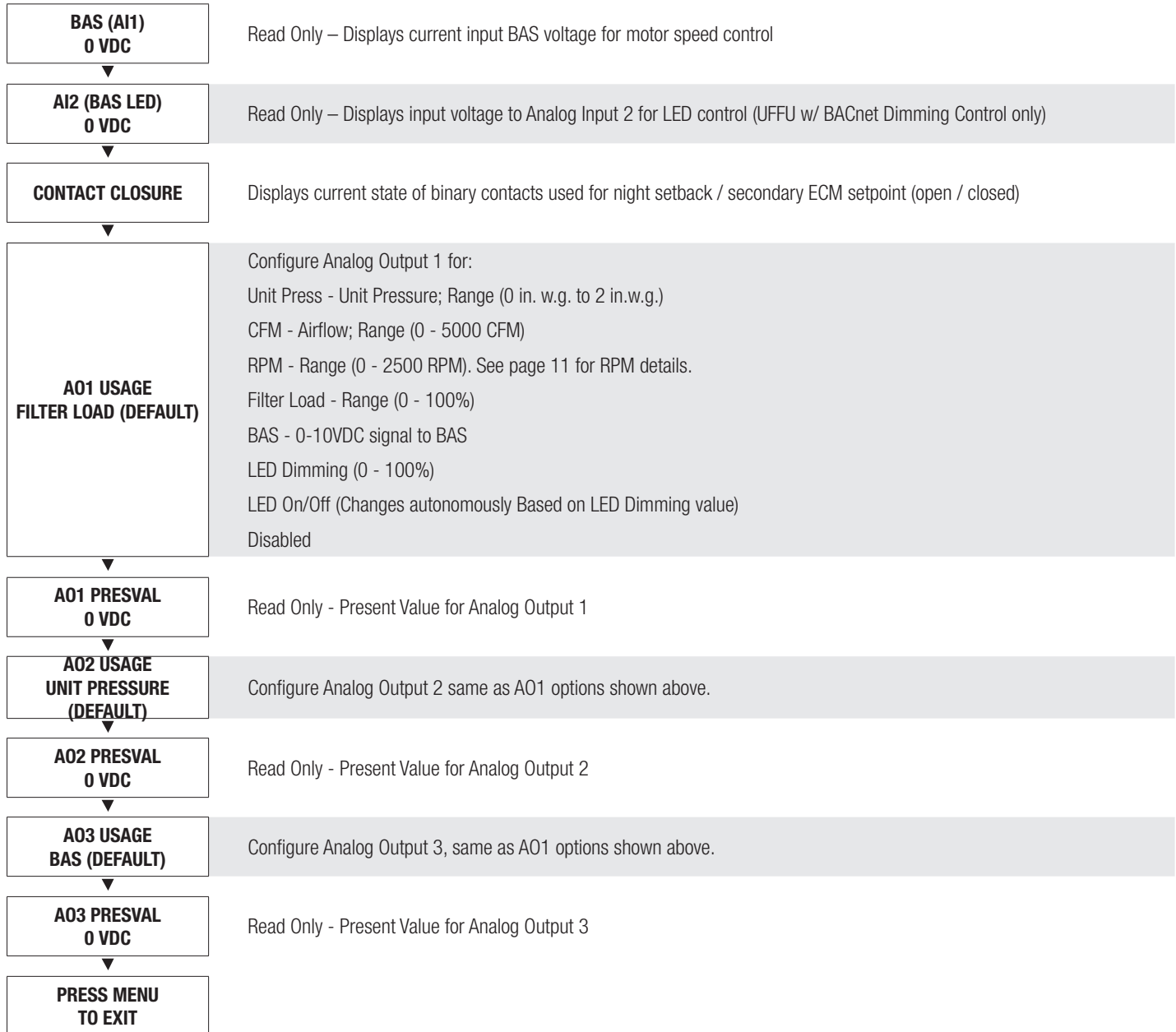

# BACNET FLOW CONTROLLER

## DISPLAY NAVIGATION

### Service Menu – BACnet

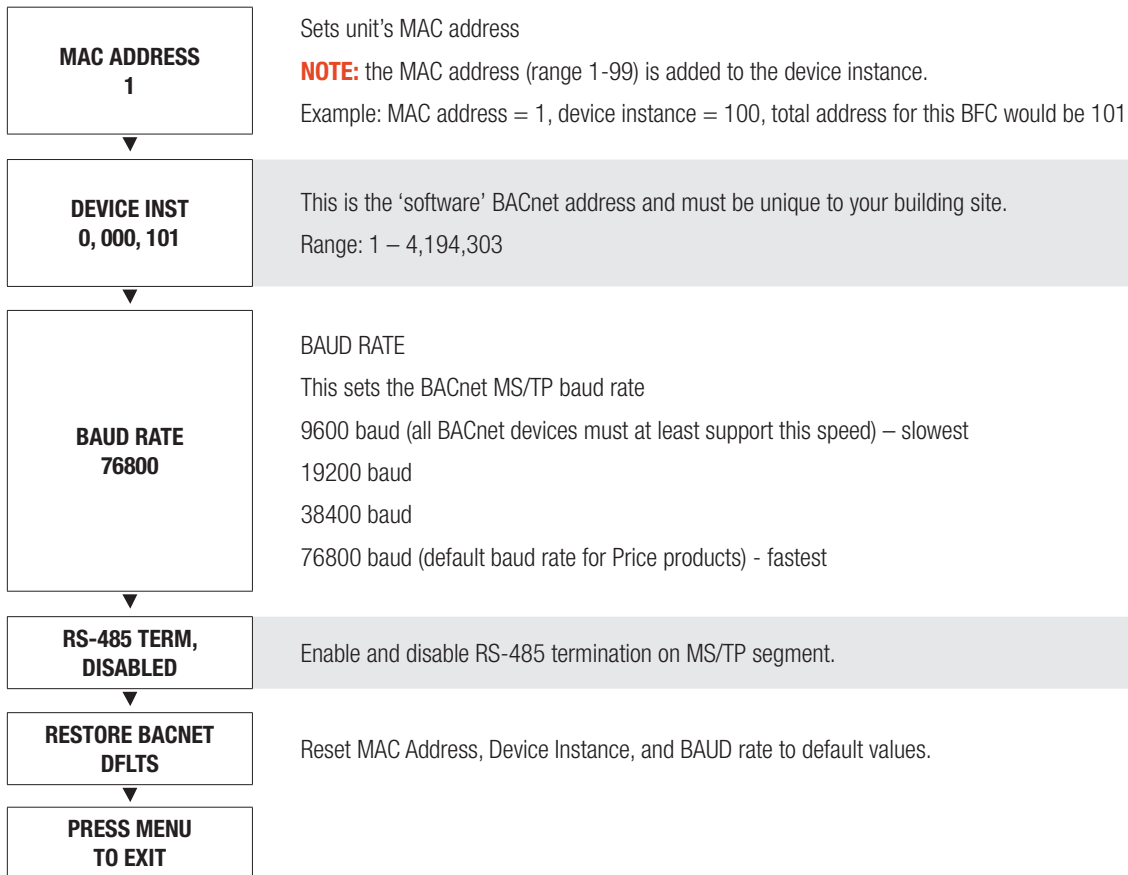

### Service Menu – Diagnostics

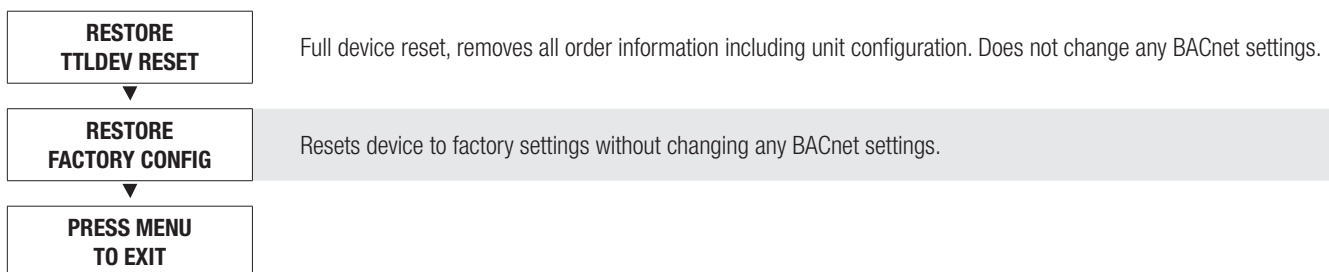

# BACNET FLOW CONTROLLER

## FILTER CALIBRATION

### Filter Calibration

To properly track filter loading, the BFC must be calibrated with the clean filter pressure. Before proceeding, ensure the unit is operating at the desired airflow. Any changes to the airflow will change the unit pressure and therefore require the filter status to be reset. For further information on airflow balancing please refer to the FFU Manual. Filter calibration can be performed either directly through the BFC interface or over BACnet. Each method is described below.

### Using the BFC Interface

**STEP 1:** To calibrate clean filter pressure drop, scroll through the 'Service Menu' until reaching 'Filter'. Select this menu by pressing the 'Enter/Menu' button (far right).

**NOTE:** To enter the Service Menu, hold down the 'Enter/Menu' button for 5 seconds. Display will show 'Passcode'. Use the Up and Down arrow buttons to enter this sequence:

**Down, Up, Up, Down.**

**STEP 2:** Scroll through the 'Filter' menu until reaching 'Reset Filter', select by pressing the 'Enter/Menu' button. **NOTE:** Make sure the area directly beneath and around the unit is clear of any personnel or equipment as this can affect the reading of the clean filter static pressure.

**STEP 3:** Press the 'Enter/Menu' button to confirm reset of filter; this will begin calibration. This will take approximately 2 minutes.

After filter calibration is complete, LCD will display: 'RESET COMPLETED'.

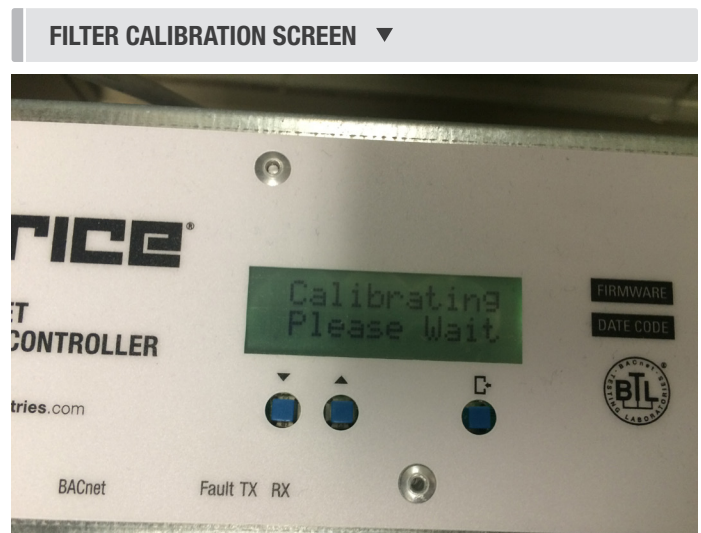

# BACNET FLOW CONTROLLER

## FILTER CALIBRATION

### Via BACnet

The steps below require the BFC to be configured and set up on a BACnet front-end system.

For further information on BFC BACnet setup, see *Networking & Setup* section.

**STEP 1:** Ensure that BACnet point AV2 – Filter Runtime is being pulled in (see table below).

**STEP 2:** Write a value of 0 to AV2 – Filter Runtime. This will initiate a calibration cycle. The current unit pressure (AI5) will be automatically be copied to the Filter Calibrated Pressure (AV5). This process takes approximately 2 minutes.

**NOTE:** Filter loading can subsequently be monitored using BACnet point: AV1 – Filter Load (from 0% clean to 100% loaded).

Object	Name	Units	Default	Range	Description	R/W
AI5	Unit Pressure	in. w.g.	Dynamic	Dynamic	Current differential pressure measured across the filter	R
AV1	Filter Load	%	0	0-100%	Current percent of filter loading based on new, clean filter pressure drop	R
AV2	Filter Runtime	Hours	0	0-99999	Current number of hours on filter since last reset. Enter value of zero after filter has been replaced to perform calibration.	R/W
AV3	Motor Runtime	Hours	0	0-99999	Current number of hours on motor since last reset	R
AV4	Airflow	cfm	N/A	0-9999	Current airflow	R
AV5	Filter Calibrated Pressure	in. w.g.	N/A	Dynamic	Unit pressure when filter was calibrated	R
AV6	Filter Trip Pressure	in. w.g.	0	Dynamic	Filter trip pressure	R
AV7	Filter Loading Trip Point	Numeric	1.5	1-3	Factory set filter loading trip point	R

# BACNET FLOW CONTROLLER

## NETWORKING & SETUP

### BACnet Wiring

The Price BACnet Flow Controller (BFC) has the option of using a CAT 5 cable to run BACnet MS/TP, or cable hardwired into a pluggable terminal block (see next page if using hardwired BACnet connections). The RJ-45 jacks for use with the supplied BACnet cables are directly tied to the pluggable terminal block, and so any combination of supplied cables and hardwired connections can be used on a single network segment.

BACnet networks must be run in a daisy chain configuration, meaning there is only one main cable and each network device is connected directly along its path, with no more than 30 devices per segment, and MS/TP segment lengths must not exceed 1050 feet.

### Termination

BACnet MS/TP networks must be terminated to ensure proper operation. A network should be terminated twice, once at the beginning and once at the end. Termination helps reduce reflections and noise. The terminating can be done with a 100 ohm resistor across the + and - lines. Termination can also be done via software using the Price BACnet Flow Controller. For more information see the BACnet Service Menu section of this manual.

**Tech Tip:** The Price BACnet MS/TP to IP Router has built in termination and it is enabled by default (since the router is typically the beginning of the entire MS/TP network). Now you only have to go and find/terminate that last device.

### Electrical Noise

Electrical noise can affect both analog signal and digital communications such as BACnet. Therefore do not route high voltage lines next to the BACnet network! Avoid noisy electrical sources such as:

- Variable Frequency Drives
- High current power lines (main panel feeds)
- Fluorescent light fixtures

If you must pass near noisy electrical lines cross at right angles. This will help reduce the amount of noise coupled to the network wires.

### BACNET WIRING ▼



### ELECTRICAL NOISE EXAMPLE ▼

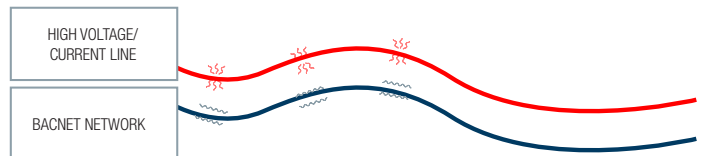

# BACNET FLOW CONTROLLER

## NETWORKING & SETUP

Use Price supplied CAT-5 cables for BACnet whenever possible. If not possible to use Price supplied cables, follow these wire specifications.

### Network Wire Specifications





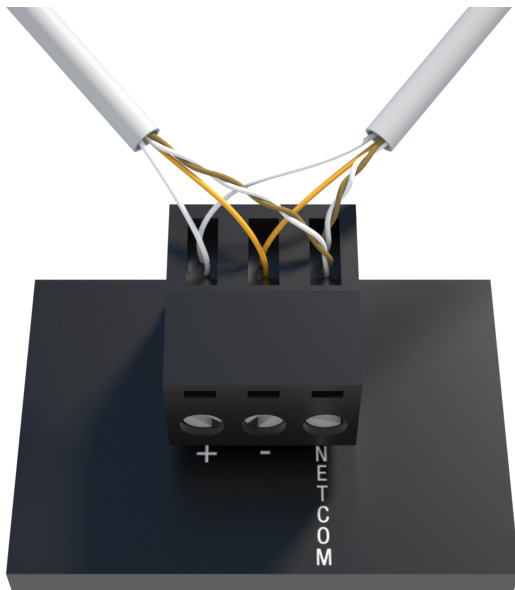

For the BACnet MS/TP network specific wire is required. Do not use standard power or “thermostat” wire. This wire does not have the necessary requirements for digital communications. While it’s possible it may work (temporarily) the network will be unreliable and not operating at optimal performance.

### BACnet MS/TP Wire type recommendations

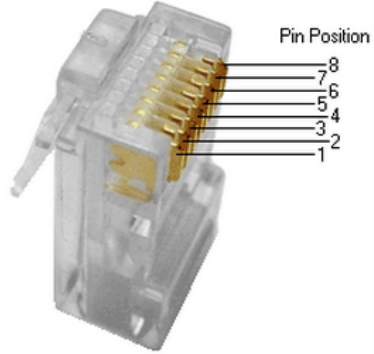
- Use 2 balanced twisted pairs, one for + and -, one for NET COM
- Low capacitance (17pF or less)
- Plenum rated (FT6, CMP ratings)
- 100-120 ohm, Balanced
- (CAT5, CAT5E, CAT6 network cable has excellent specifications and will work in almost any BACnet MS/TP application.)
- **Price controllers use the Orange Compliment for (+), the Orange for (-), and the Brown and Brown Compliment together for the (NET COM) connections. These are paired in a standard CAT5E cable.** Pre-terminated CAT5 cables are available from Price. Model code: NETC35 (35 ft plenum rated cable, terminated with RJ45 plugs, 568-B standard)

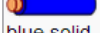

### WIRING ▼

	T568B Color	Pins on plug face (socket is reversed)
PIN 1	 white/orange stripe	
PIN 2	 orange solid	
PIN 3	 white/green stripe	
PIN 4	 blue solid	
PIN 5	 white/blue stripe	
PIN 6	 green solid	
PIN 7	 white/brown stripe	
PIN 8	 brown solid	

Use RJ45 jacks for BACnet connection, or 3 position terminal block for 3-wire connection (+, -, NET COM) NET COM must be wired.

# BACNET FLOW CONTROLLER

## NETWORKING & SETUP

### BACnet Service Menu

Each controller's MAC address, Device Instance, and Baud rate are set in the BACnet sub-menu of the service menu accessed through the LCD screen on the face of the BFC. For information on how to select a MAC address and Device instance for any controller on a network, see following pages.

To set the controller's BACnet settings, enter the **Service Menu** and adjust settings as follows:

**NOTE:** When the screen displays a flashing value, that value is ready to be changed and can be adjusted by pressing the arrow keys. Pressing Menu will save the value.

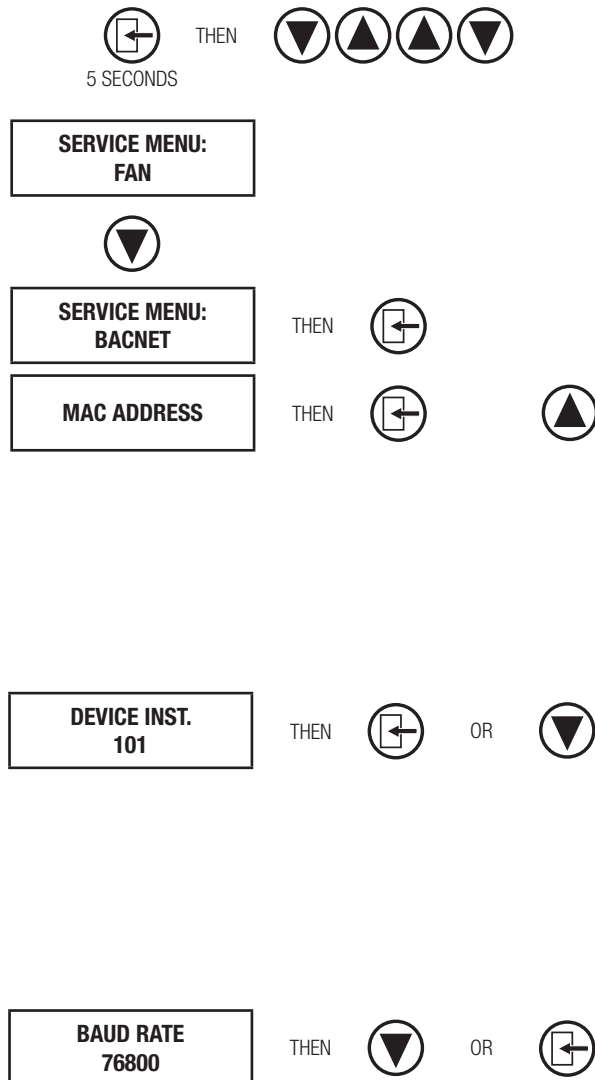

Hold down the **Menu** button on the LCD Thermostat for **5 seconds** until prompted for a passcode; use and to enter the passcode; **DOWN, UP, UP, DOWN**.

The screen will now display “SERVICE MENU: FAN”

Scroll down to the BACnet sub-menu.

Press the **Menu** button to enter this menu.

Screen will now show “MAC ADDRESS = 1”. This is the default setting and can be programmed between 1 and 99 by pressing **Menu** and using the UP and DOWN arrows ( ).

Use to scroll to whatever MAC you are intending to set this controller to, once you arrive at the number, press **Menu** to save

**NOTE:** By default, the MAC address will appear as the last 2 digits of the device instance.

The device instance defaults to 100, but will be displayed with the last 2 digits as the MAC if the previous screen was set to enabled. Press Menu then use the arrow keys to change the device instance.

**NOTE:** Each Menu press will change allow changes in different tiers of the device instance (so that you don't have to scroll for extended periods to get into the millions range – supposing that's where you need to set your device instance)

The baud rate is the speed that the MS/TP network runs at. EVERY device on the network must run at the same speed. Price controllers are defaulted to a baud rate of 76800, but can be changed to 38400, 19200, or 9600. For a network segment with all Price controllers, it's recommended that the baud rate be left at 76800.

\*Choose lower baud rates only when integrating with devices by other manufacturers whose maximum speed is lower than 76800 (eg. 38400).

Once all settings are made scroll down to the 'Press Menu to Exit' screen and press **Menu**. The controller will then re-start which will save these values.



# BACNET FLOW CONTROLLER

## NETWORKING & SETUP

### BACnet Networking and Setup

#### Setting the MAC Address:

MAC (media access control) must be UNIQUE on an MS/TP network segment within building. An installer setting up an MS/TP segment must ensure each device has a UNIQUE MAC Address (Range 1-99). The MAC Address is set through the LCD thermostat or LCD setup tool.

**NOTE:** Each device on a network segment must be set to run at the same speed or baud rate.

#### NETWORK SEGMENT #1 ▼

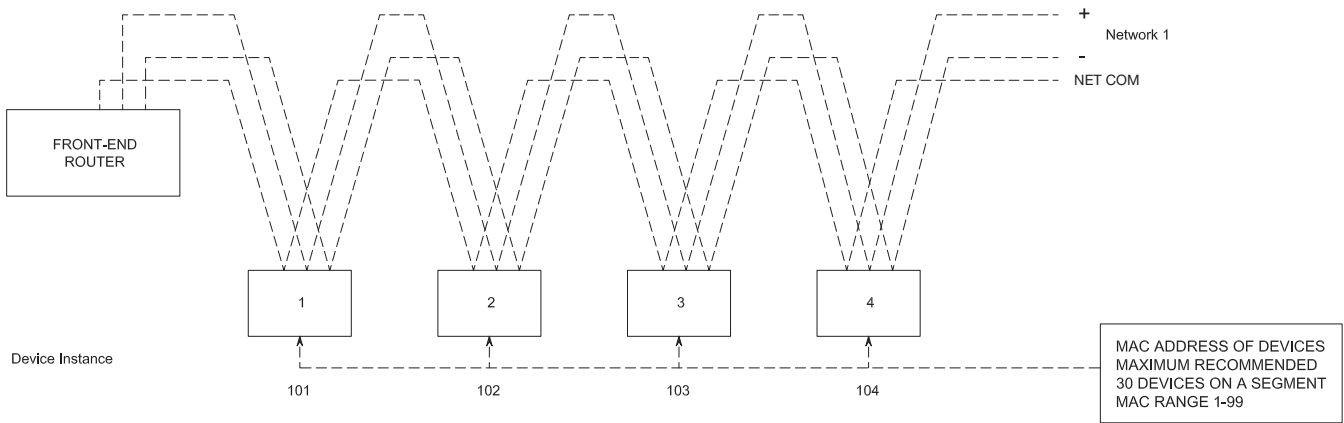

#### NETWORK SEGMENT #2 ▼

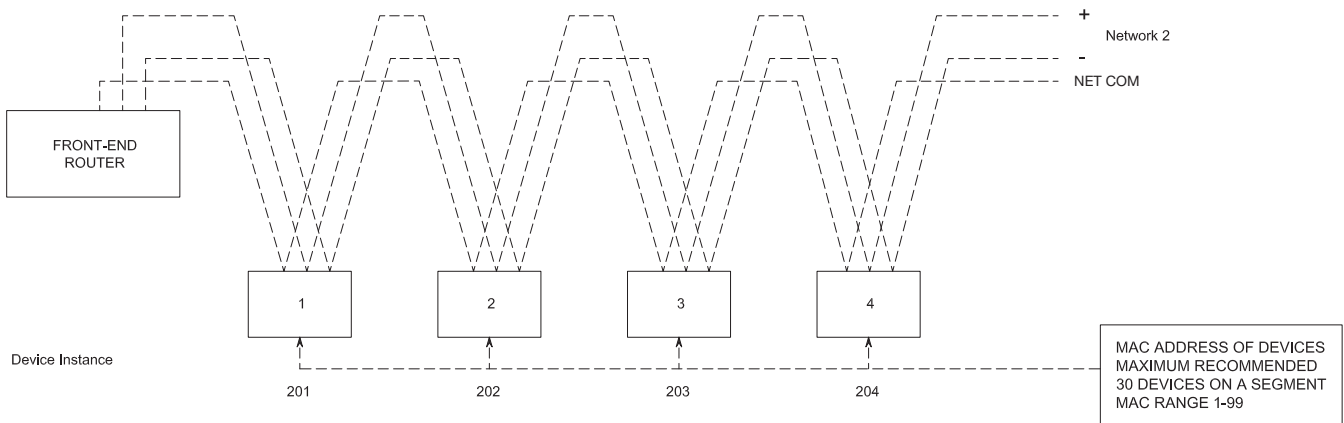

### TECH TIP ▼

24 VAC power HOT and COMMON polarities are critical and must not be reversed on ANY devices! Reverse polarity will stop communication on that MS/TP segment. All 24 VAC transformers must be grounded on their secondary side for BACnet to work.

NET COM wire must be connected at each device and is critical for BACnet network reliability.

Use one twisted pair for + and -, and another twisted pair for NET COM for optimal noise cancellation.

# BACNET FLOW CONTROLLER

## NETWORKING & SETUP

### Setting the Device Instance (Coupled MAC and DI)

#### Device Instance:

A Device Instance number identifies a device within an entire building, therefore giving it a unique number or Address, much like a telephone ext. number. A building can have one telephone number, but all the extensions have a unique number to identify them. A Device Instance number would work the same way and must be unique throughout the building.

Below is a table defining how a Device Instance number is obtained.

**NOTE:** Each device on a network segment must be set to run at the same speed or baud rate.

Description	Default Value (Factory)	Notes
MAC Address	6	Value: limited to 1-99
Tier 1 (x100)	58	Value: limited to 0-99
Tier 2 (x10,000)	1	Value: limited to 0-99
Tier 3 (x1,000,000)	0	Value: limited to 0-4

#### Example Device Instance setup with Default settings:

- MAC Address = 6 (6 x 1 = 6) – Set through software

+

TIER 1 = 58 (58 x 100 = 5800) – Set through software

+

TIER 2 = 1 (1 x 10,000 = 10,000) – Set through software

+

TIER 3 = 0 (0 x 1,000,000 = 1,000,000) – Set through software

=

Final Device Instance = 0,015,806

<input type="text" value="0"/>	<input type="text" value="01"/>	<input type="text" value="58"/>	<input type="text" value="06"/>
Tier3	Tier2	Tier1	MAC
Multiplier	Multiplier	Multiplier	Address

# BACNET FLOW CONTROLLER

## NETWORKING & SETUP

### Setting the Device Instance (De-coupled MAC and DI)

#### Device Instance:

A Device Instance number identifies a device within an entire building, therefore giving it a unique number or Address, much like a telephone ext. number. A building can have one telephone number, but all the extensions have a unique number to identify them. A Device Instance number would work the same way and must be unique throughout the building.

Below is a table defining how a Device Instance number is obtained.

**NOTE:** Each device on a network segment must be set to run at the same speed or baud rate.

Description	Example Value	Notes
Tier 1 (x01)	4	Value: limited to 1-99
Tier 2 (x100)	58	Value: limited to 0-99
Tier 3 (x10,000)	1	Value: limited to 0-99
Tier 4 (x1,000,000)	0	Value: limited to 0-4

#### Example Device Instance setup with Default settings:

- TIER 1 = 4 (4 x 1 = 4) – Set through software

+

TIER 2 = 58 (58 x 100 = 5800) – Set through software

+

TIER 3 = 1 (1 x 10,000 = 10,000) – Set through software

+

TIER 4 = 0 (0 x 1,000,000 = 1,000,000) – Set through software

=

Final Device Instance = 0,015,806

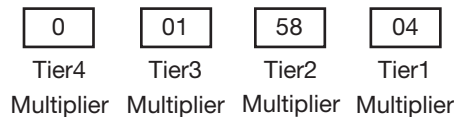

# BACNET FLOW CONTROLLER

## NETWORKING & SETUP

### Network Layout

The BFC can be connected over BACnet MS/TP and added to an existing BAS front end system. Price also offers its own mini front-end system known as FFU-BFC-FE which acts as a graphics package. The Price WEB Server allows the user to view variables such as filter status, CFM, etc. for each FFU and modify setpoints as needed.

### Devices

**Webserver:** Provides the graphical web interface, plugs into IP Router. 2000 node capacity.

**IP Router:** Acts as interface between Internet and internal system. 5 ports. 1 Port for Building WAN (Internet/Building Network – You cannot plug a BACnet Router or IP Switch into this port). 4 LAN Ports available (Used for BACnet Routers and IP Switches).

**BACnet Router:** Interfaces between BACnet MS/TP system and IP Router (internet). Supports 30 FFU.

**IP Switch:** Expands available connections for BACnet router. 5 ports.

### CONNECTION EXAMPLE (LESS THAN 30 UNITS) ▼

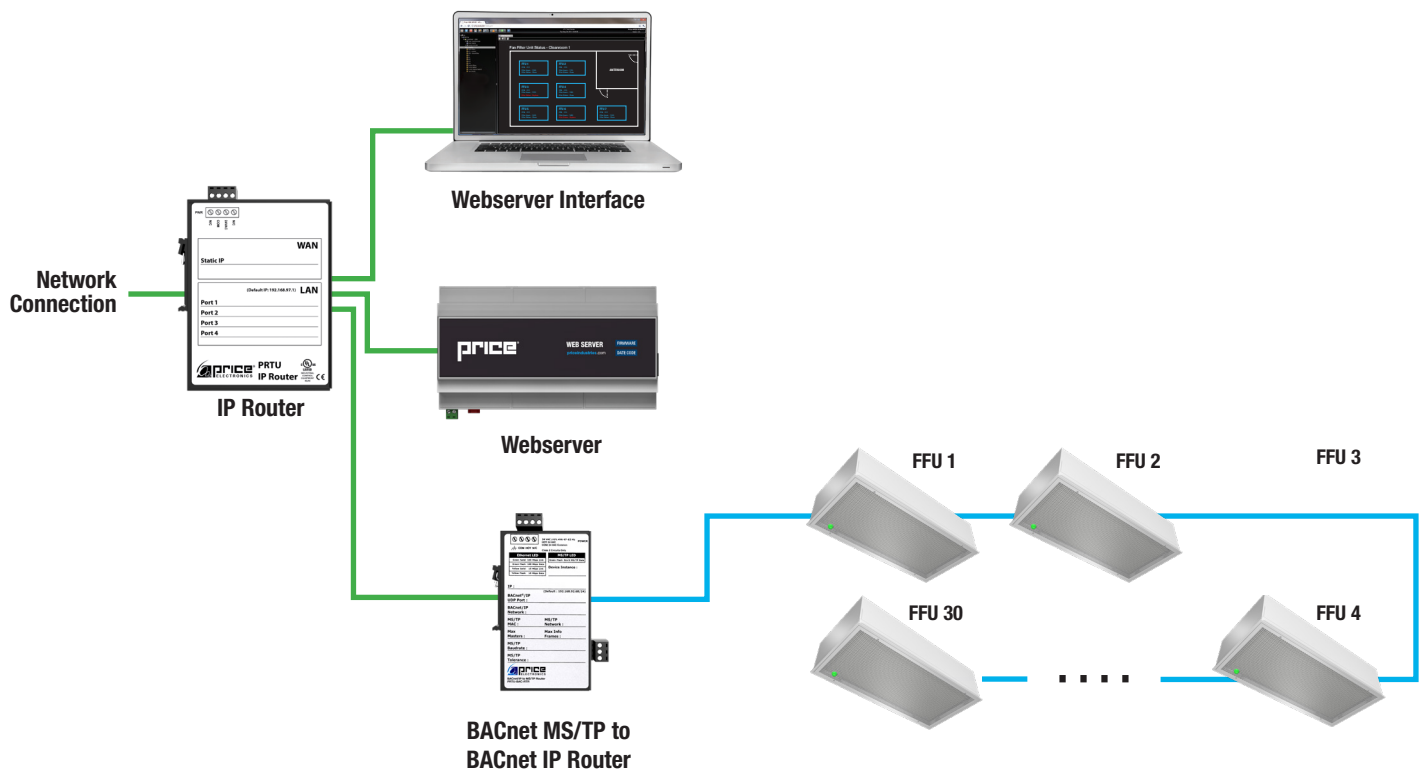

# BACNET FLOW CONTROLLER

## NETWORKING & SETUP

### CONNECTION EXAMPLE (GREATER THAN 30 UNITS) ▼

**WIRING**

- Power
- Ethernet Network
- MS/TP Network

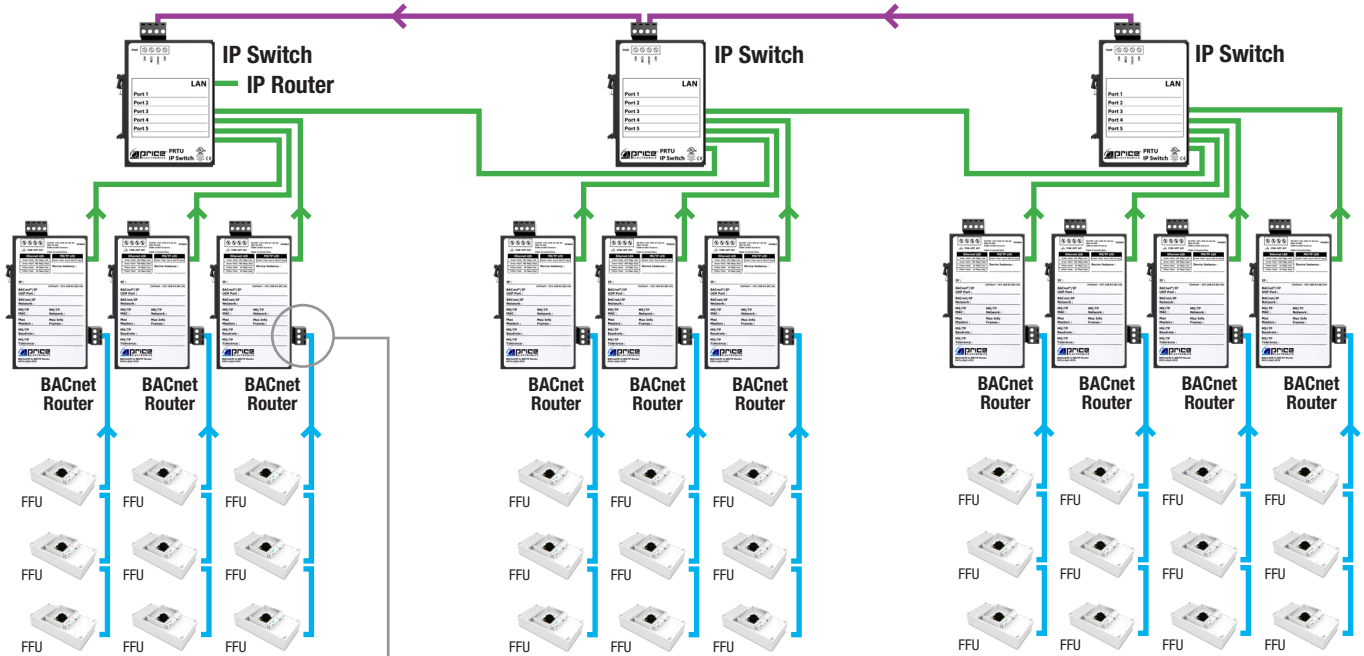
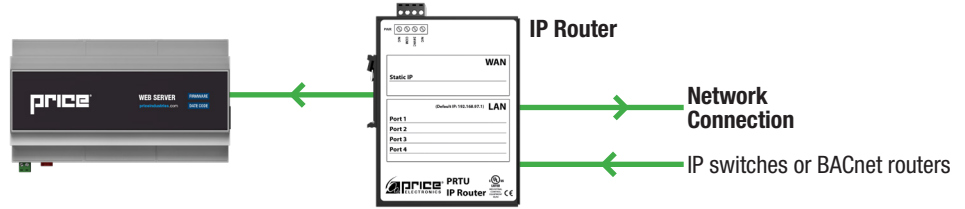

- Up to 30 FFUs on each BACnet router.

- Up to 30 FFUs on each BACnet router.

- Up to 30 FFUs on each BACnet router.  
 - When no more IP Switches are required to add more FFU's, up to 4 BACnet Routers can be connected to the final switch.

**BACNET WIRING**

- 
- +
- NETCOM



### Example Systems

Max # of Units	QTY of BACnet Routers	QTY of IP Switches	QTY of IP Router
30	1	0	1
60	2	0	1
90	3	0	1
120	4	1	1
150	5	1	1
180	6	1	1
210	7	2	1
240	8	2	1
270	9	2	1
300	10	3	1
330	11	3	1

Assumes two ports on IP router are filled with BACnet routers (i.e. 60 FFU's total).

More units are supported, contact Critical Environments applications team for more information.

# BACNET FLOW CONTROLLER

## NETWORKING & SETUP

### Package/Component Identification

#### Web Additional

The WEB-ADDITIONAL package is used to connect additional FFU systems to the WEB-MASTER system.

#### Components:

##### 250000-931 - PRTU Bacnet Router

1. PRTU-BAC-RTR
2. NETC2 cable  
(to connect to PRTU-IP-RTR)
3. DIN Rail

#### PRTU IP Switch

The IP-SWITCH is required if there are more than 3 PRTU systems being connected to the Web Server. This component is used to expand the “LAN” port on the IP-RTR, allowing a further 3 PRTU systems to be connected. See the example layout section of this manual for further detail.

#### Examples:

- 1-3 PRTU Systems:  
No IP Switch required
- 4-6 PRTU Systems:  
Qty: 1 IP Switch required
- 7-9 PRTU Systems:  
Qty: 2 IP Switch required

#### Components:

##### 250000-933 - PRTU IP Switch

1. PRTU-IP-SWITCH
2. NETC2 cable  
(to connect to PRTU-IP-RTR)
3. DIN rail

Please ensure you have all components before proceeding. Inspect components for shipping damage. Do not install components that appear damaged. Contact your local PRICE Sales Rep for quick ship replacements.

As always, for the latest information and video please visit [priceindustries.com](http://priceindustries.com).

### 250000-931 - PRTU BACNET ROUTER ▼



1. PRTU-BAC-RTR

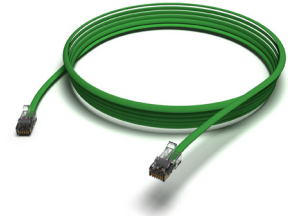

2. NETC2 CABLE



3. DIN RAIL

### 250000-933 - PRTU IP SWITCH ▼

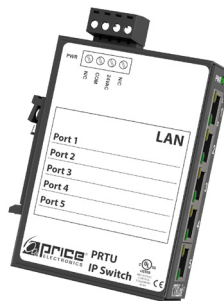

1. PRTU-IP-SWITCH



2. NETC2 CABLE



3. DIN RAIL



# BACNET FLOW CONTROLLER

## NETWORKING & SETUP

### Mounting

Use the included DIN rail to securely mount the Front-End components.

1. Using 3 screws (by others) mount the DIN rail horizontally to a secure, accessible surface.
2. Hang the Price PRTU-WEB onto the DIN rail using the TOP white clips.
3. Using the Price Electronics screwdriver, gently pull down on the BLACK clip, while pushing gently on the WEB-SERVER towards the DIN rail. The Price Web Server should click securely into place.
4. Use the mounting clips on the rear of the BAC-RTR, IP-RTR, or IP-SWITCH to mount the components to the din rail. Slip the top clip behind the DIN rail flange, then use steady pressure to push the component down then back towards the DIN rail to secure.
5. The same section of DIN rail can be used to mount multiple components.

BACK VIEW OF WEB-SERVER ▼

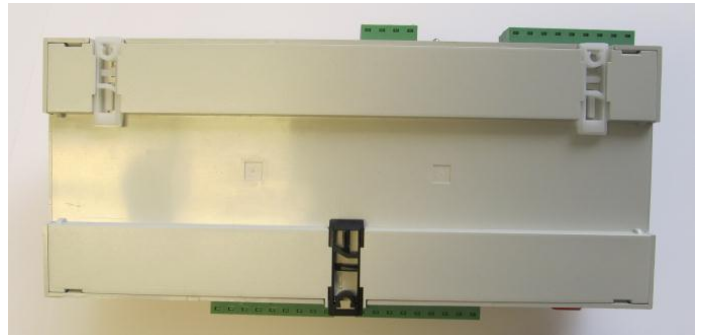

FRONT VIEW OF WEB-SERVER MOUNTED ON DIN RAIL ▼



REAR VIEW OF IP-RTR AND BAC-RTR ▼



SAMPLE FRONT-END MOUNTING ON DIN RAIL ▼





# BACNET FLOW CONTROLLER

## NETWORKING & SETUP

### BAS Input Signal

The BAS input signal overrides the local setpoint using a remote 0 – 10VDC signal. If the BAS signal drops below 1VDC local control (via the push buttons) is restored.

BAS Voltage	Response	Notes
0-1 VDC	Local control mode using push buttons	Local setpoint can be adjusted from 0 – 100% using push buttons
1-2 VDC	Motor Off	Recommend sending a 1.5 VDC signal to command motor off
2-9 VDC	Modulating Control	2 – 9 VDC modulates motor from 0 – 100%
9-10 VDC	Maximum Speed	Motor is running at maximum speed (100%)

BAS equations exist in each fan powered terminal product service and installation manual to relate CFM to volts DC. The VDC in the equations however are for the 1-5 volt scale of voltage measured across the manual mode POT taps. The BAS input voltage is a 2-10 VDC scale, and therefore VDC calculated for a given CFM using the equation **must be doubled** to achieve that cfm using the BAS input. See standard speed controller BAS section for an example of calculating the voltage required for a specific CFM.

If the BFC will be connected to BACnet, the BACnet motor speed setpoint will override both the BAS analog input, and the local setpoint for motor speed control.

Motor speed setpoint priorities are:

1. BACnet
2. BAS analog signal
3. Local setpoint adjust

# BACNET FLOW CONTROLLER

## NETWORKING & SETUP

### Analog RPM Feedback

A two wire connection supplies an analog (0-10 VDC) signal that is directly proportional to the MOTOR 1 RPM. The range is 0 – 2500 RPM and it will output a proportional 0 – 10 VDC signal. If a dual blower system is used, only the RPM of motor 1 can be read.

**NOTE:** The minimum speed of an ECM is approximately 250 RPM. Formula for outputs below (tolerance +/- 5%):

- VDC output = (RPM /250)
- Rpm = (VDC \* 250)

Output signal: 0 – 10 VDC @ 20 k ohm minimum input impedance and is short circuit protected (output impedance is 511 ohm to protect against incorrect wiring).

- Black Wire – Analog RPM output com (-)
- White Wire – Analog RPM output signal (+)

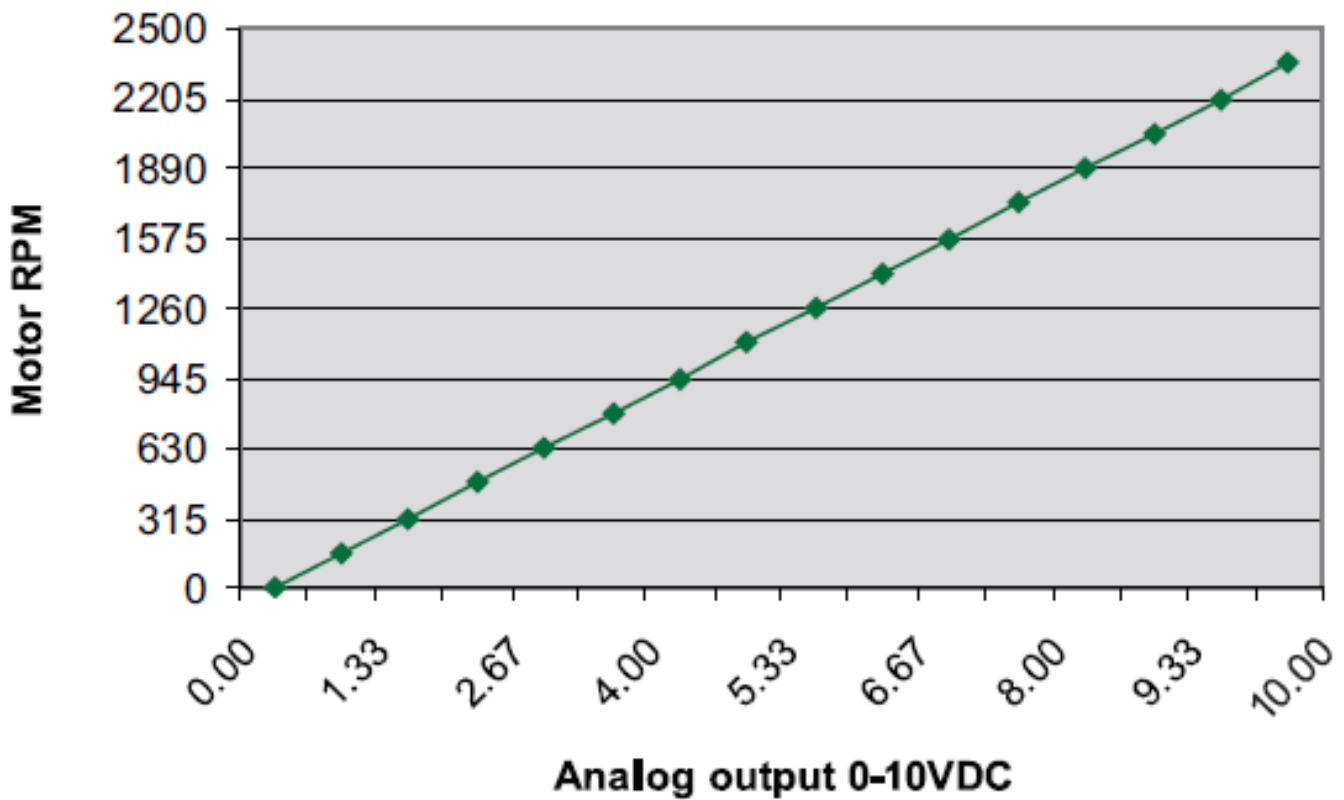

# BACNET FLOW CONTROLLER

## NETWORKING & SETUP

### Wiring and Cables

**\*For In depth ECM motor troubleshooting, please refer to ECM Troubleshooting Manual on Price Industries' website.**

The ECM speed controller requires 24 VAC power from a transformer and outputs control signals to the ECM motor on dual MTA-100 jacks. Either jack or both jacks can be used (for dual fan systems).

The control cable (with RED connector) **must be plugged into the circuit board correctly.** (See Figure 2)

**FIGURE 2 - ECM STANDARD SPEED CONTROLLER WITH CONTROL CABLE PLUGGED INTO MTR1** ▼

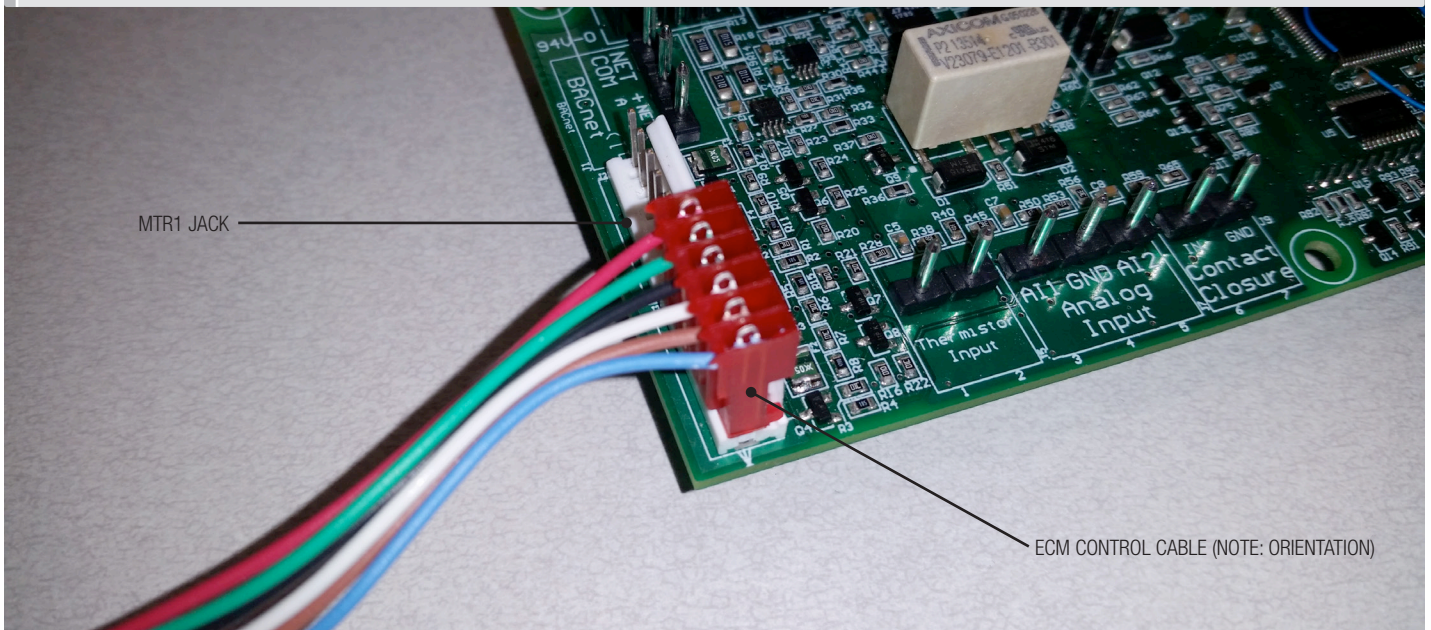

**NOTE:** Make sure that this cable is connected properly. It is keyed one way, and make sure all of the pins are covered.

# BACNET FLOW CONTROLLER

## MAINTENANCE

### Troubleshooting

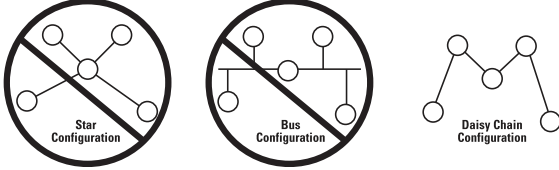
Fault	Solution
Binary Outputs not functioning	The Binary outputs send out 24VAC and are factory wired to the LED on the FFU. Make sure the BFC has 24VAC power, and then check voltage at binary outputs and COM terminals if the LED does not light up.
Analog Outputs not functioning	The Analog outputs send out 0-10VDC. Make sure the BFC has 24VAC power, and then check voltage at the suspect analog output with a multimeter. You should see a voltage range of 0-10VDC.
<p>BACnet Communication Errors</p> 	<p><b>Option #1</b></p> <p>BACnet - MS/TP is based on a RS-485 network. It must be wired in a daisy chain configuration. A daisy chain means that there is only one main cable, and every network device is connected directly along its path.</p>  <p>DO NOT use Star, Bus, "T", or any other type of network configuration. Any of these other network configurations will result in an unreliable network, and make troubleshooting almost impossible.</p> <p>Correct polarity is imperative on MSTP wiring. Always ensure that the positive terminal on a device has the same color wire connected to it throughout the network, same for the negative terminal. Eg. 2 wire conductor with black and white wires – black to the positive terminal, and white to the negative terminal. Keep this consistency throughout the network.</p> <p><b>Option #2</b></p> <p>Price does not use EOL or termination on their devices. Terminating a device is almost never required at the low baud rate of MS/TP devices. In fact terminating can create more problems than it solves.</p> <p>The network speed or baud rate must be the same throughout the network.</p> <p><b>NOTE:</b> The default speed for Price BACnet MS/TP controls is 76800. BACnet MS/TP currently supports 4 standard speeds which are: 9600, 19200, 38400 and 76800.</p> <p><b>Option #3</b></p> <p>Binary Address must be unique for each device on the network. No two devices can have the same Address. This includes if you are incorporating a Price product into an existing network. Determine the existing Addressing scheme for the existing network.</p> <p><b>Option #4</b></p> <p>Grounding and 24VAC polarity: Proper grounding is absolutely essential when wiring the MS/TP BACnet Network. Proper grounding will prevent many potential problems that can occur in a network of devices. Common symptoms of a poorly grounded network can include inconsistent BACnet MS/TP communications and damage from voltage spikes. The most practical method of grounding is to ground every 24VAC transformer common/neutral used to power the controls.</p> <p>Connect the "common/neutral" wire of the SECONDARY side of the transformer to earth ground – such as the ground screw on in the electrical box.</p> <p><b>Option #5</b></p> <p><b>NOTE:</b> Flipping 24VAC HOT and COMMON will cause the BACnet MS/TP Network to stop communicating!!! Ensure HOT and COMMON are not reversed on ANY controllers.</p> <p><b>WARNING:</b> Controllers will still power up and run even if HOT and COMMON are reversed. However output signals to other devices such as heaters, relays, etc will not work as intended!</p>

# BACNET FLOW CONTROLLER

## MAINTENANCE

### Specifications

<b>Power:</b>	Pluggable 24 VAC, 50/60 Hz, 50 VA Class 2
<b>Input Power:</b>	24 VAC, 50/60 Hz, 5 VA (plus external loads), Class 2
<b>Environmental (operating):</b>	10°C to 50°C (50°F to 122°F), 0% to 95% RH (non-condensing)
<b>Environmental (storage):</b>	-30°C to 50°C (50°F to 122°F), 0% to 95% RH (non-condensing)
<b>Inputs:</b>	1 Thermistor Input (10K Ohm, Type J) 2 Analog Inputs: 0-10 VDC 1 Contact Closure Input
<b>Outputs:</b>	3 Binary Outputs (24 VAC) for LEDs 3 Analog Outputs (10 mA maximum, 0-10 VDC) 2 ECM motor connections
<b>Networking:</b>	BACnet (MS/TP)
<b>Indicators:</b>	BACnet RX/TX and Fault lights

# BACNET FLOW CONTROLLER

## MAINTENANCE

### BACnet points list for BFC firmware v3.2.0

Object	Name	Units	Default	Range	Description	R/W	RETAINED ON POWER FAILURE
AI1	Analog Input 1 (BAS)	Volts DC	Dynamic	Dynamic	0-10 VDC Signal for remote fan speed control	R	N
AI2	Analog Input 2 (LED)	Volts DC	Dynamic	Dynamic	0-10 VDC Signal for remote LED dimming (Only for UFFU w/ BACnet Dimming option)	R	N
AI3	Thermistor	°F/°C	Dynamic	(-59)-300	Current air temperature over filter	R	N
AI4	ECM Speed	r/min	Dynamic	0-2500	Current RPM of motor	R	N
AI5	Unit Pressure	in. w.g.	Dynamic	Dynamic	Current differential pressure measured across the filter	R	N
BI1	Contact Closure	Contacts Open/ Closed	Dynamic	Contacts Open/ Closed	Binary Input for monitoring only	R	N
AO1	Analog Output 1 Filter Load	Volts DC	N/A	0-10 VDC	Configurable for Unit Pressure, CFM, RPM, Filter Load , BAS, *LED Dimming, *LED On/ Off (*for UFFU w/ BACnet Dimming)	R/W	Y
AO2	Analog Output 2 Unit Pressure	Volts DC	N/A	0-10 VDC	Configurable for Unit Pressure, CFM, RPM, Filter Load , BAS, *LED Dimming, *LED On/ Off (*for UFFU w/ BACnet Dimming)	R/W	Y
AO3	Analog Output 3 (BAS)	Volts DC	N/A	0-10 VDC	Configurable for Unit Pressure, CFM, RPM, Filter Load , BAS, *LED Dimming, *LED On/ Off (*for UFFU w/ BACnet Dimming)	R/W	Y
AO4	ECM Setpoint	%	50	0-100	Set ECM motor setpoint	R/W	Y
AV1	Filter Load	%	0	0-100%	Current percent of filter loading based on new, clean filter pressure drop	R	N
AV2	Filter Runtime	Hours	N/A	0-99999	Current number of hours on filter since last reset. Enter value of zero after filter has been replaced and calibrated.	R/W	Y
AV3	Motor Runtime	Hours	N/A	0-99999	Current number of hours on motor since last reset	R	N
AV4	Airflow	Cfm	N/A	0-9999	Current airflow	R	N
AV5	Filter Calibrated Pressure	in. w.g.	N/A	Dynamic	Unit pressure when filter was calibrated	R	N
AV6	Filter Trip Pressure	in. w.g.	0	Dynamic	Filter trip pressure	R	N
AV7	Filter Loading Trip Point	Numeric	1.5	1-3	Factory set filter loading trip point	R	Y

# BACNET FLOW CONTROLLER

## MAINTENANCE

### BACnet points list for BFC firmware v3.2.0

Object	Name	Units	Default	Range	Description	R/W	RETAINED ON POWER FAILURE
AV8	ECM Setback Setpoint	%	0	0-100%	Set the secondary ECM motor setpoint activated by closure of the Binary Contact (BI1)	R/W	Y
AV9	ECM CFM Offset	Cfm	0	(-9999)-9999	Set a fixed offset for adjusting CFM readout	R/W	Y
AV10	ECM CFM Tweak	%	100	0-200%	Set a percent offset for adjusting CFM readout	R/W	Y
AV11	LED Dimming Setpoint	%	0	0-100%	Set LED dimming percentage (for UFFU w/ BACnet Dimming)	R/W	Y
AV12	No Load Pressure	Text	-1	(-1)-1	Calibrate filter by writing 1	R/W	N
AV13	ECM Fan Status	Text	Dynamic	4 States	Displays motor status: 1 - Off, 2 - Normal, 3 - No RPM, 4 - Overspeed	R	N
AV14	Filter Calibrating	Text	Dynamic	2 States	Displays filter calibration status: 0 - Calibration Complete, 1 - Calibrating	R	N
AV15	BAS Enabled	Text	Dynamic	2 States	0 - No AI1 BAS Signal, 1 - AI1 BAS signal present	R	N
AV16	BAS LED Enabled	Text	Dynamic	2 States	0 - No AI2 BAS Signal, 1 - AI2 BAS signal present	R	N
MV1	Unit Status	Text	Dynamic	4 States	1 - Off, 2 - Low Pressure, 3 - Normal, 4 - Filter Loaded	R	N
MV2	Control Mode	Text	Dynamic	3 States	1 - BACnet, 2 - BAS, 3 - Local	R	Y
MV3	Motor Program	Text	Dynamic	2 States	1 - Constant Torque, 2 - Constant Volume	R	Y
MV4	Unit Size	Text	Dynamic	3 States	1 - 2x2, 2 - 2x3, 3 - 2x4	R	Y
MV5	Unit Filter Type	Text	Dynamic	2 States	1 - BTR, 2 - RSR	R	Y
MV6	Unit Wheel Type	Text	Dynamic	2 States	1 - FC, 2 - BC	R	Y
MV7	Unit Voltage Type	Text	Dynamic	3 States	1 - 115, 2 - 240, 3 - 277	R	Y
MV9	AO1 Usage	Text	Dynamic	8 States	1 - Disabled, 2 - RPM, 3 - Filter Load, 4 - BAS, 5 - Unit Press, 6 - LED (On/Off), 7 - LED (Dimming), 8 - CFM	R	Y
MV10	AO2 Usage	Text	Dynamic	8 States	1 - Disabled, 2 - RPM, 3 - Filter Load, 4 - BAS, 5 - Unit Press, 6 - LED (On/Off), 7 - LED (Dimming), 8 - CFM	R	Y
MV11	AO3 Usage	Text	Dynamic	8 States	1 - Disabled, 2 - RPM, 3 - Filter Load, 4 - BAS, 5 - Unit Press, 6 - LED (On/Off), 7 - LED (Dimming), 8 - CFM	R	Y
MV12	RS-485 Term.	Text	Dynamic	2 States	0 - Disabled 1 - Enabled	R	Y
MV13	Baud Rate	bps	Dynamic	4 States	0 - 9600, 1 - 19200, 2 - 38400, 3 - 76800	R	Y

---

This document contains the most current product information as of this printing.  
For the most up-to-date product information, please go to [priceindustries.com](http://priceindustries.com)

© 2022 Price Industries Limited. All rights reserved.

**PRICE<sup>®</sup>**